

VS5, VS5 SD, VS6, VS6 SD

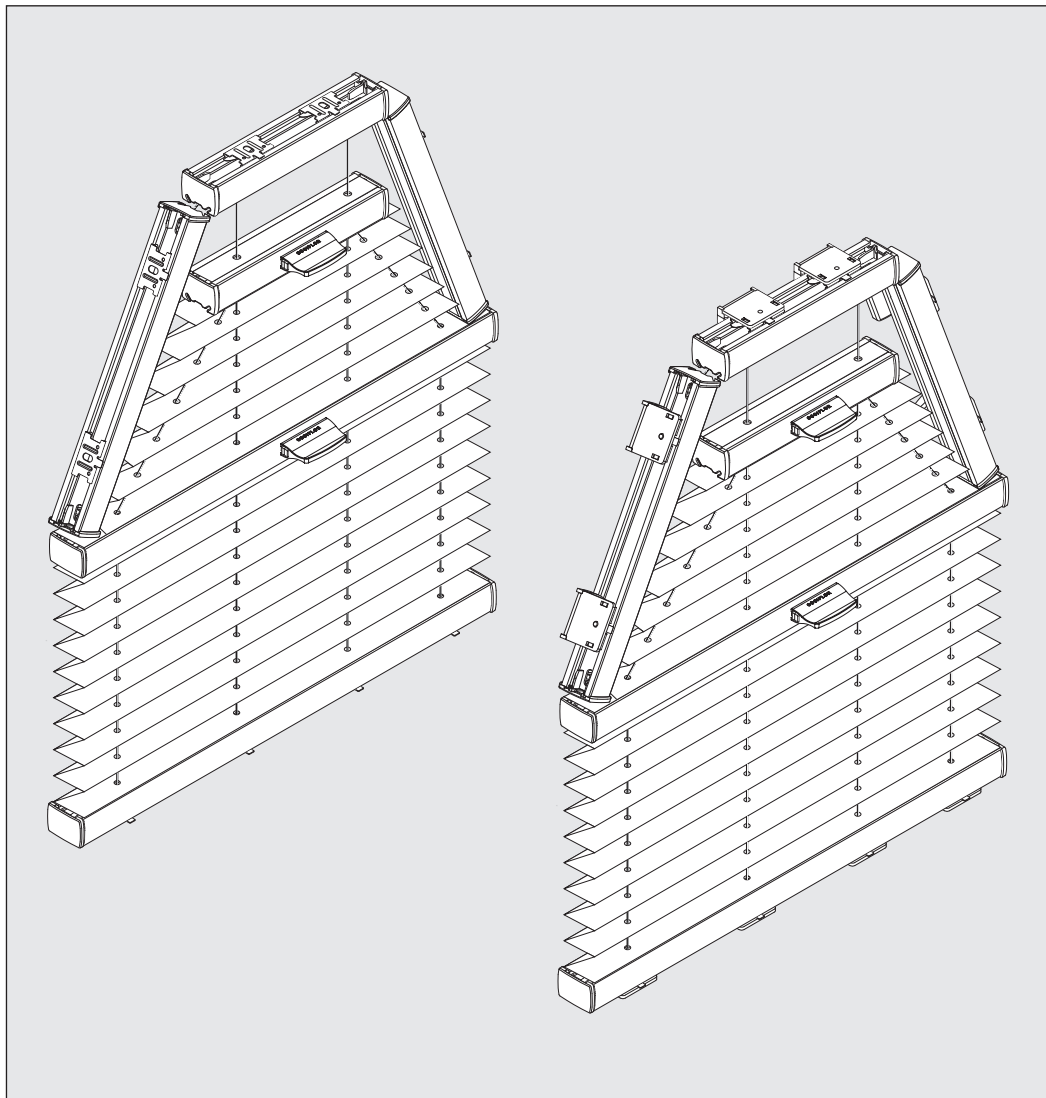

Wichtig! Bitte mit der Pflegeanleitung aufbewahren! • Important! Please keep together with care instructions!
Ważne! Proszę przechowywać z instrukcją pielęgnacji! • Внимание! Хранить вместе с инструкцией по эксплуатации!

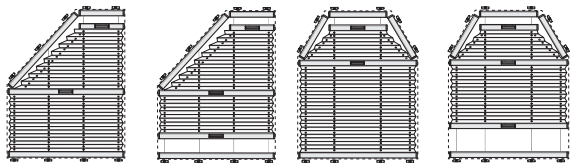
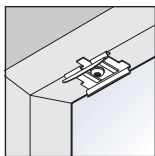

Falzmontage
Top fixing
Montaż w świetle szyby
Монтаж в проем

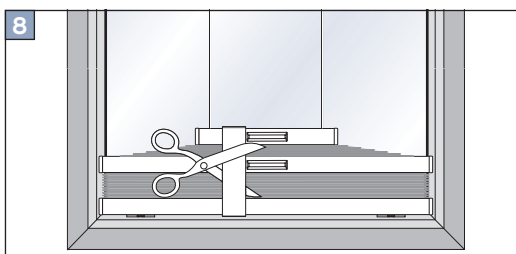
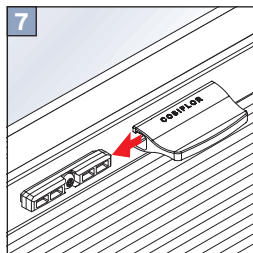
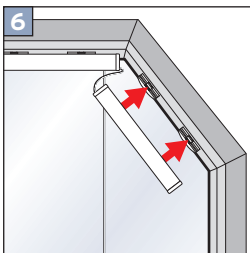
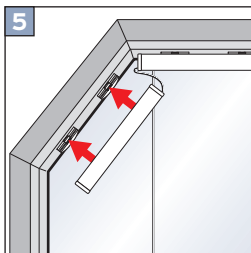
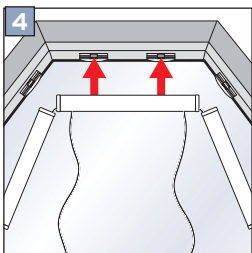
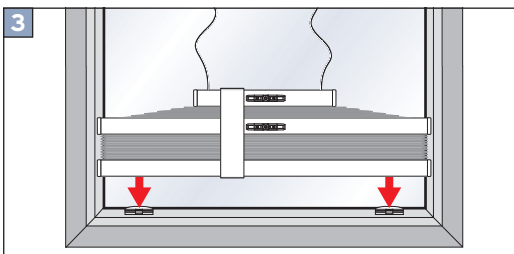
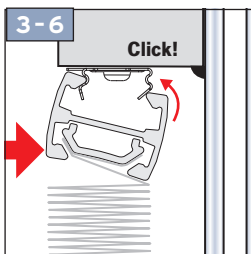
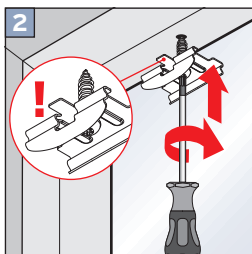
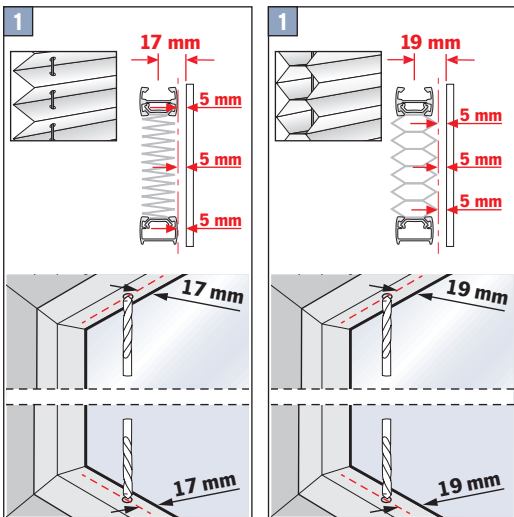
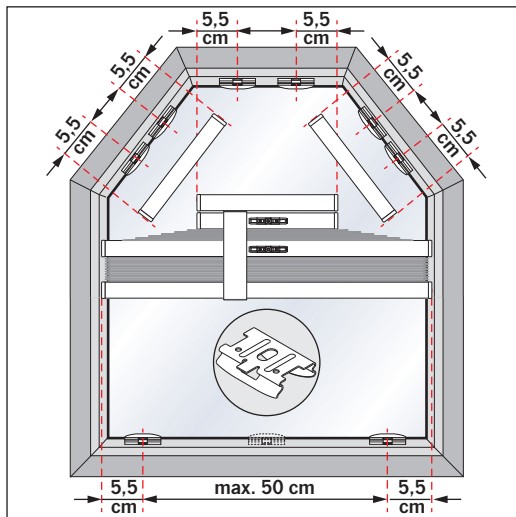
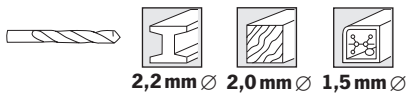

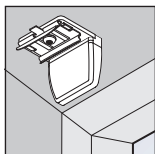

Winkelmontage
Face fixing
Montaż frontalny (nawierzchniowy)
Монтаж на проем

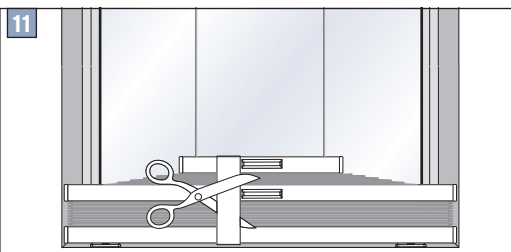
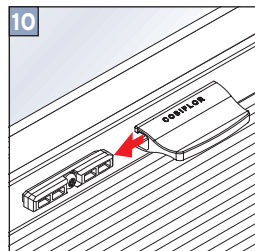
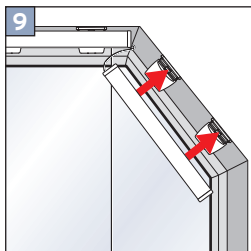
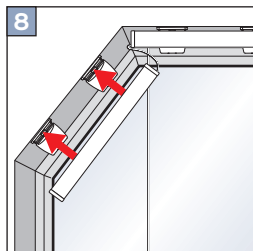
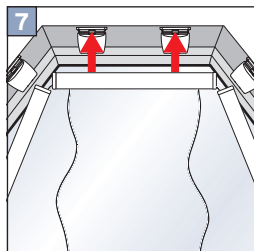
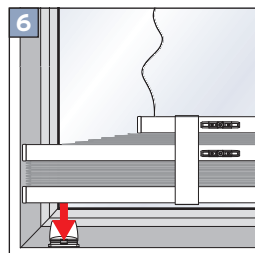
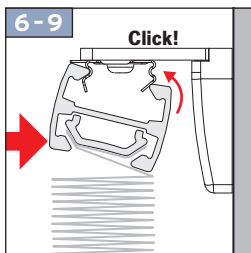
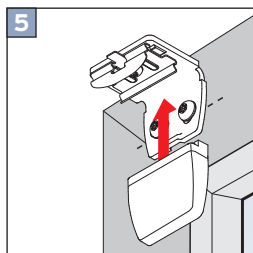
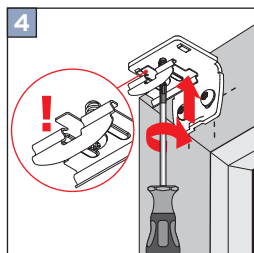
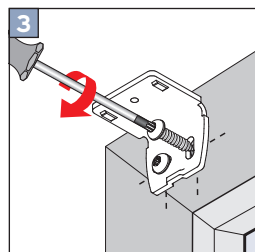
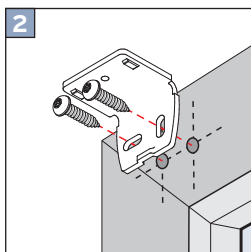
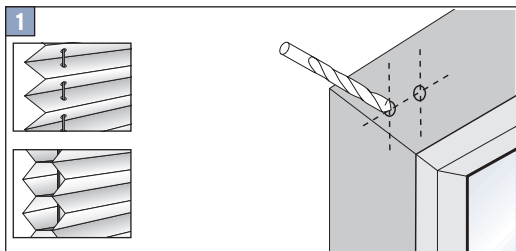
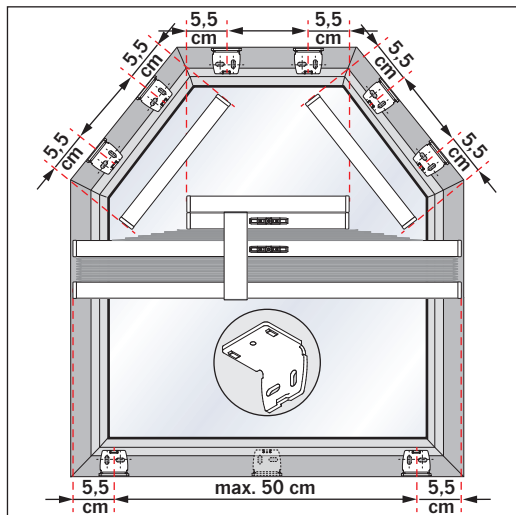

Bedienung • Operation • Obsługa • Управление

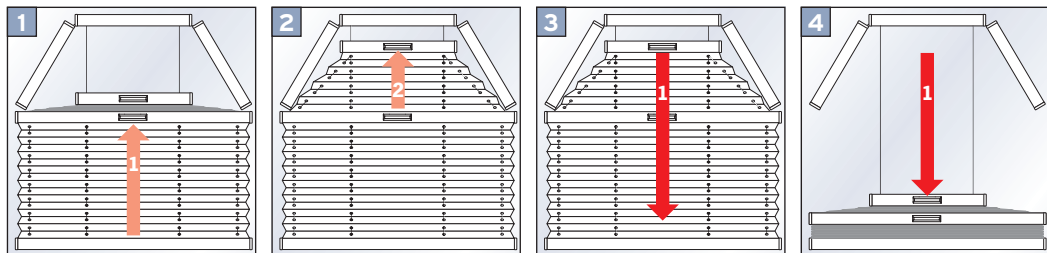

Demontage • Disassembly • Demontaż • Демонтаж

Falzmontage • Top fixing • Montaż w świetle szyby • Монтаж в проем

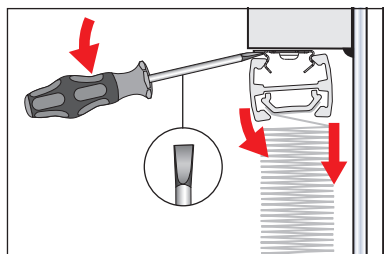

Winkelmontage • Face fixing • Montaż frontalny (nawierzchniowy) • Монтаж на проем

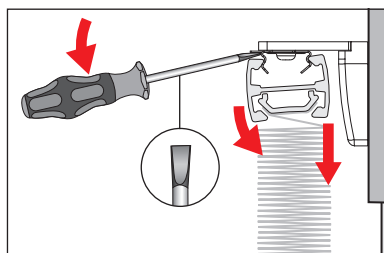

Option • Opcja • Вариант

