

PL 32, PL 33

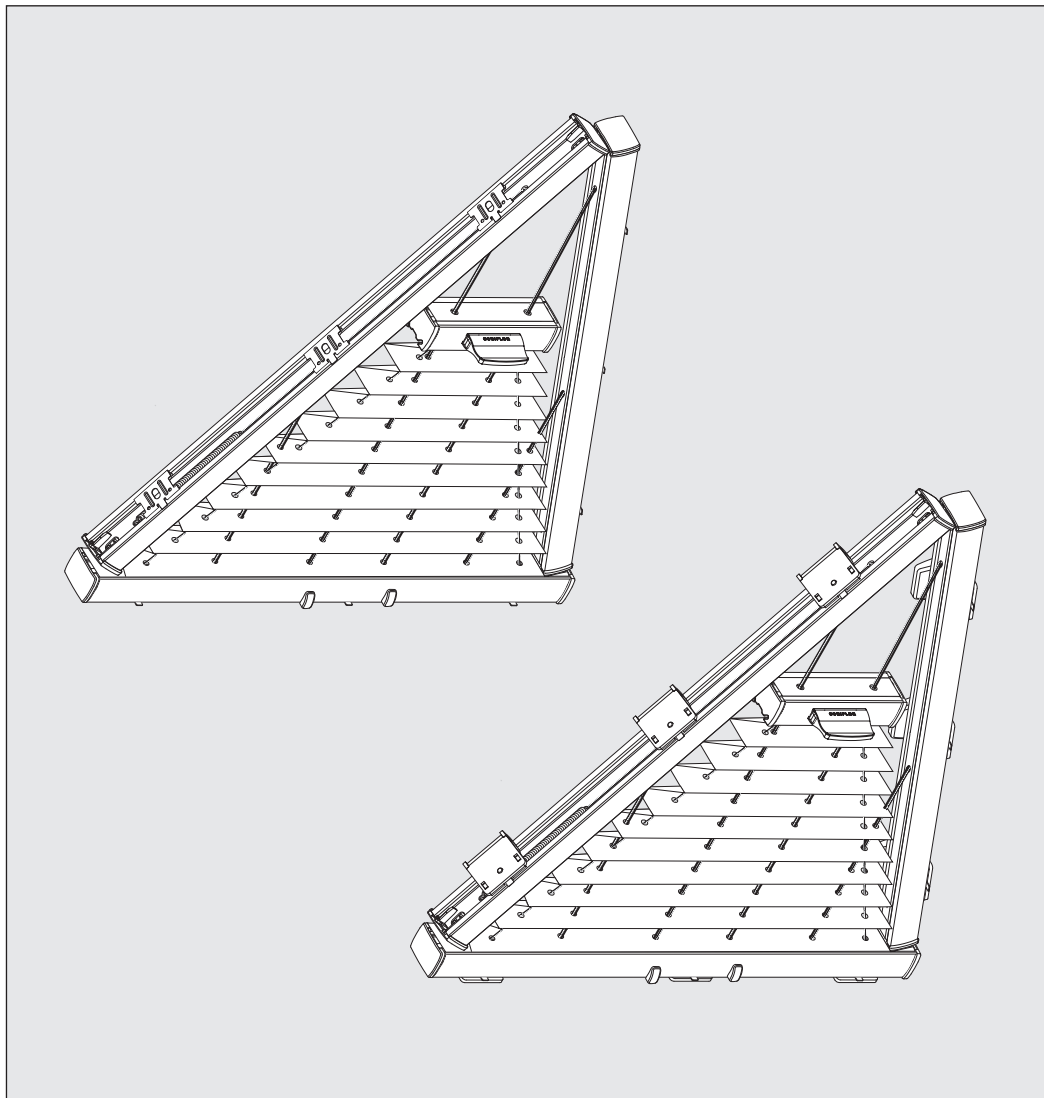

Wichtig! Bitte mit der Pflegeanleitung aufbewahren! • Important! Please keep together with care instructions!
Ważne! Proszę przechowywać z instrukcją pielęgnacji! • Внимание! Хранить вместе с инструкцией по эксплуатации!

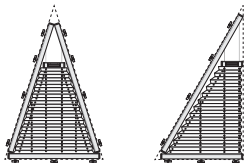
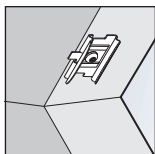

Falzmontage
Top fixing
Montaż w świetle szyby
Монтаж в проем



2,2 mm Ø 2,0 mm Ø 1,5 mm Ø

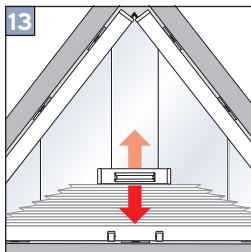
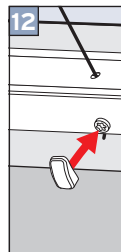
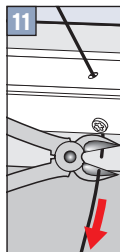
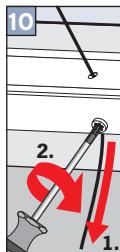
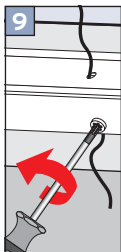
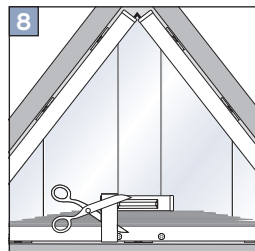
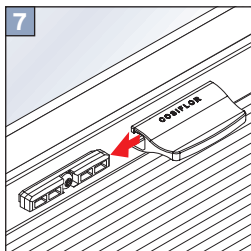
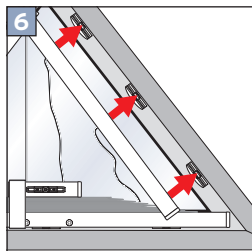
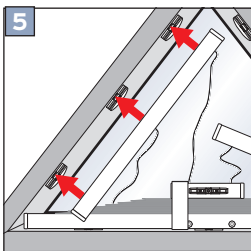
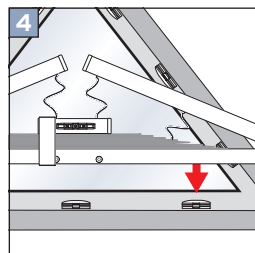
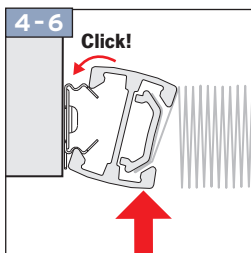
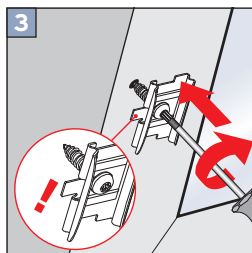
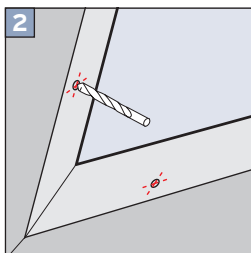
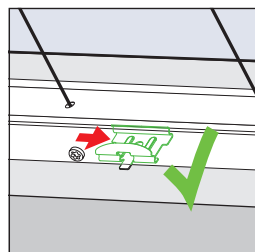
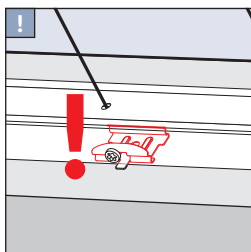
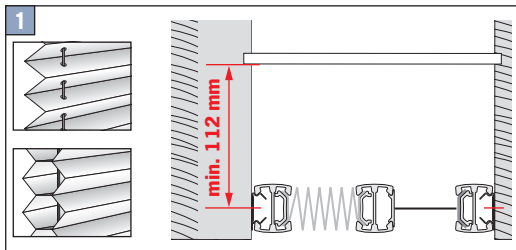
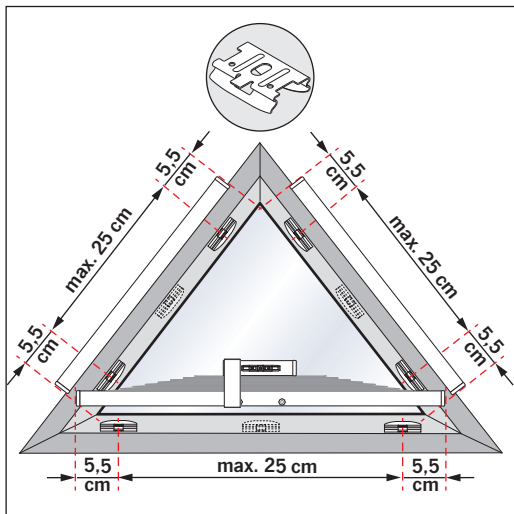

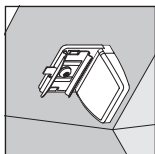

Winkelmontage
Face fixing
Montaż frontalny (nawierzchniowy)
Монтаж на проем

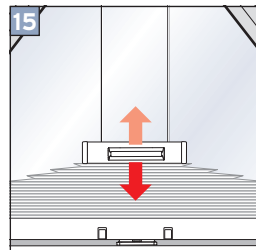
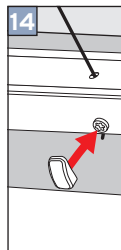
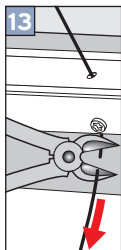
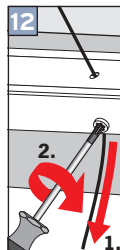
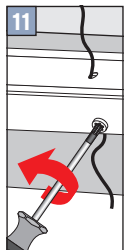
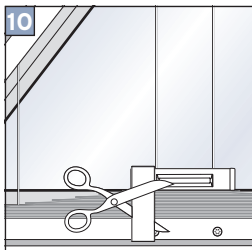
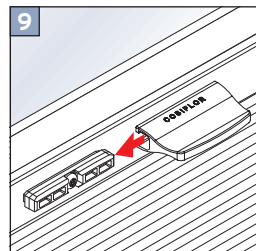
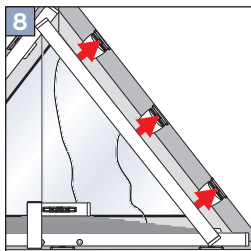
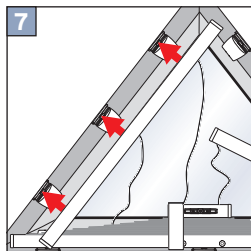
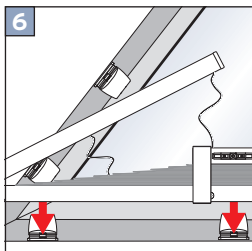
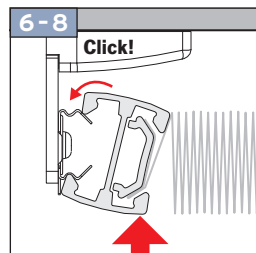
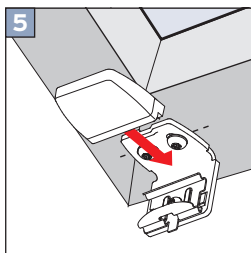
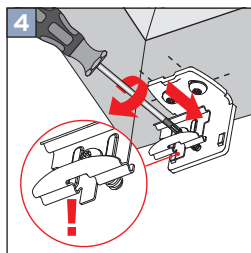
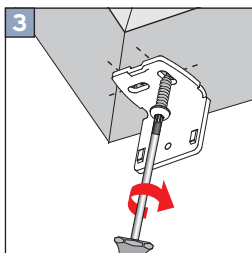
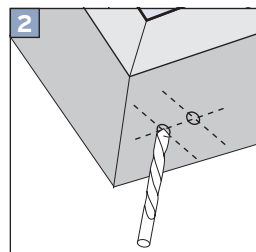
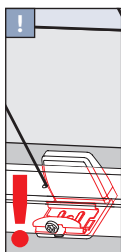
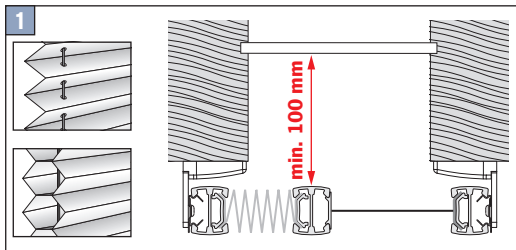
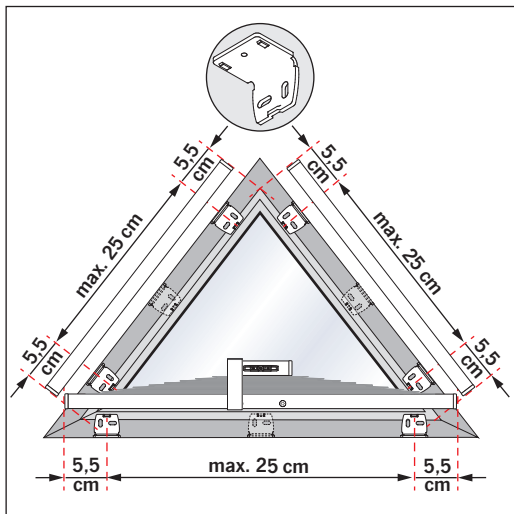

Demontage • Disassembly • Demontaž • Демонтаж

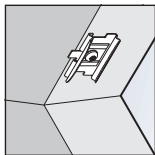

Falzmontage
Top fixing
Montaż w świetle szyby
Монтаж в проем

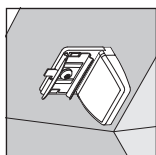
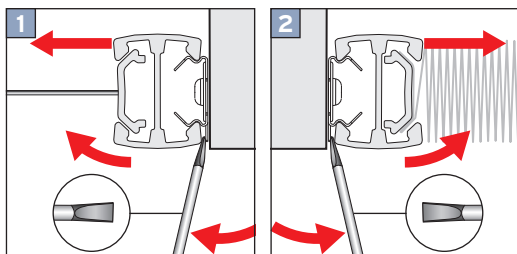

Winkelmontage
Face fixing
Montaż frontalny (nawierzchniowy)
Монтаж на проем

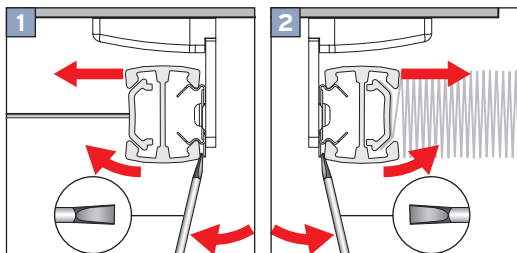

Option • Опція • Вариант

